



Hypervisor Market Overview

Franz Walkembach

for GENIVI® AMM, April 19th, 2018 (Munich)



Hypervisor Market Overview

What you can expect

- **Quick introduction of SYSGO AG**
- **What are the market trends for hypervisor?**
- **Market size and main vendors**
- **Which use cases can be addressed?**
- **Which Hypervisor types are visible in the market?**
 - With focus on MMU (less MPU)
- **Which impact on Certification in automotive?**
- **Summary & Outlook**

SYSGO AG

Embedded Software Technology Leader

Mission

“Be the leading European Operating System provider for devices in the Internet of Things: wherever safety and security matter, certified whenever needed.”



Founded

1991 (Mainz, Germany)

>80% Engineers have safety certification competences

Since 2012 independent entity from the Thales Group



Local

Facilities in Germany, France, Czech Republic, UK

Global

Worldwide distribution and support network



The Market - Automotive Market Trends

Security is not an option – Security is an integral system property



Cluster

- High Safety
- High Security
- High Real-Time
- High Graphics
- Fast Boot
- Certification



ADAS/Gateway

- High Safety & Security
- Artificial Intelligence
- High Real-Time
- Low/No Graphics
- High Image Processing
- AUTOSAR
- Certification



IVI

- Low Safety
- High Security
- Medium Real-Time
- High Graphics
- High Connectivity
- Open OS (Android, Linux)
- No Certification

ECU Consolidation

- Safety/Security
- Legacy AUTOSAR
- Interconnect CAN, LIN, FlexRay, ETH
- Certification



Virtual ECU

- Safety/Security
- Certification
- Multicore
- High performance

Hypervisor Market Overview

Global Market Overview



* Global Revenue of Embedded Hypervisors & Secure Operating Systems and Related Services (Millions of Dollars)
Source: VDC Research, 2016



Hypervisor Market Overview

Main vendors visible in the embedded market

Open source

- EPAM on XEN
- General Dynamics (Oklabs)
- HIS (Wittenstein OpenRTOS)
- Intel ACRM
- Kernkonzept
- KVM Linux
- Micrium (Micro COS3)
- Siemens Jailhouse
- Sierraware on ARM
- Real-time Linux
- Perseus 32bit on XEN
- XEN-project

Proprietary

- DDC-I (DEOS)
- eSOL (eT-kernel)
- Greenhills (Integrity)
- Harman/Samsung (Red Bend)
- LynxOS
- Mentor Graphics (Nucleus)
- Open Synergy (COQOS)
- Perseus 64bit on ARM
- QNX (Neutrino)
- Real-time Systems
- SYSGO AG (PikeOS)
- Wind River (VxWorks 653)

Hypervisor Market Overview

What is a Hypervisor?

- Virtual Machine Monitor
- Runs one or more virtual machines
- Each virtual machine is called a guest machine or personality
- Has a guest operating systems with a virtual operating platform
- Manages the execution of the guest operating systems

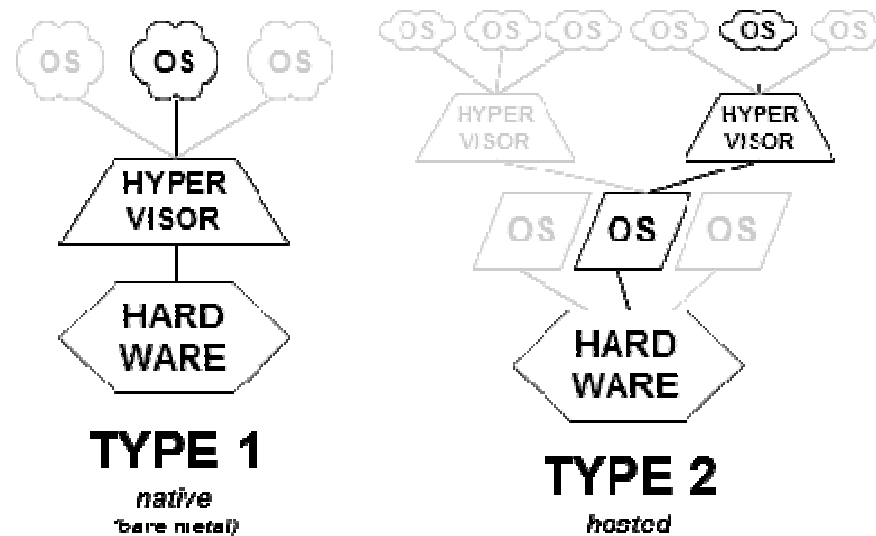

Acc. To Wikipedia

Hypervisor Market Overview

Hypervisor main use cases in automotive 1/2

- **Space / Weight / Power reduction by consolidation**
 - e.g. digital cluster and IVI on one hardware
- **Re-use of legacy code**
 - Use existing code of ECUs for new projects
- **Fast boot / Secure boot**
 - Boot via RTOS to get early access on e.g. CAN network
- **Configuration of Personalities**
 - Running open source stacks (Android/Linux) and/or RTOS in different partitions
 - Configure time schedules and memory allocation

Hypervisor Market Overview

Hypervisor main use cases in automotive 2/2

- **Safety use cases**
 - Define and separate safe from un-safe partitions
- **Security use cases**
 - Define communication flow and separate un-secure partitions
- **Use of open source in a safe and secure environment**

Hypervisor Market Overview

Some basics

- Emulation
- Applications running directly on hypervisor
- Fully virtualized OS with applications
- Para virtualized OS with API

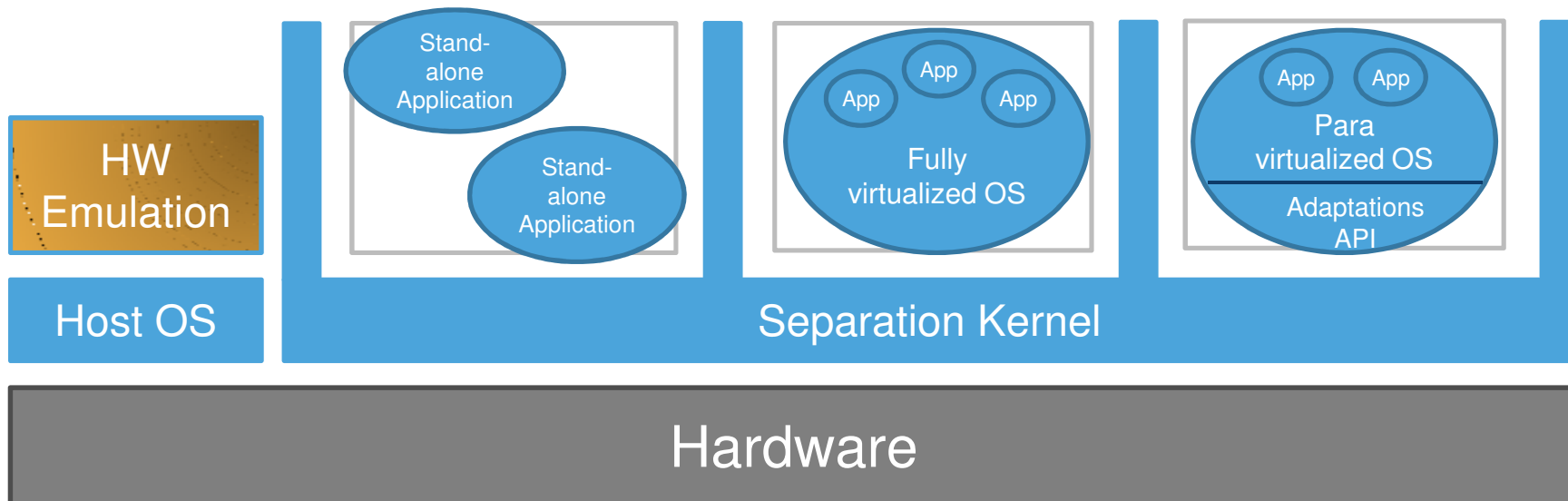

Hypervisor Market Overview

Emulation

- Complete hardware emulation
- Different hardware platforms can be emulated
- Main drawbacks :
 - performances impacted
 - I/O are emulated
 - MMU is emulated
 - all in supervisor mode is emulated, ...
- Ex.: Bochs, Qemu, ...

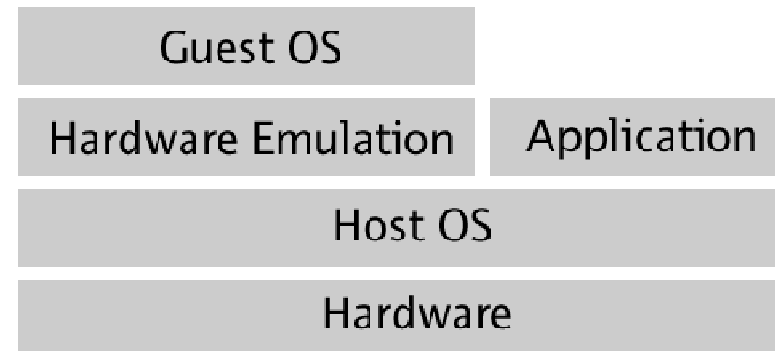

Hypervisor Market Overview

Classical virtualization

- Hardware virtualization but without any processor emulation
 - target processor must be identical to virtualized processor
- Allow some Operating Systems (Guest OS) to be hosted with no modification
- Main drawbacks: same as emulation
- Ex.: VMWare, VirtualBox, Adeos, ...

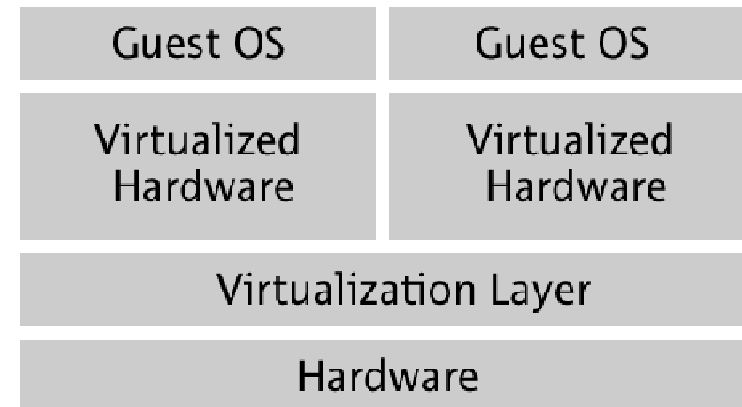

Hypervisor Market Overview

Para-virtualization

- GuestOSs must be adapted
- How to communicate safely between Operating Systems?
- Need to host a Real-Time Kernel as a GuestOS when real-time is required
 - some solutions do not offer real-time support at all with a micro-kernel
- Main drawbacks:
 - no hard real-time support possible
 - solution barely suitable for critical embedded systems, ...
- Ex.: XEN, z/VM, VLX, ...

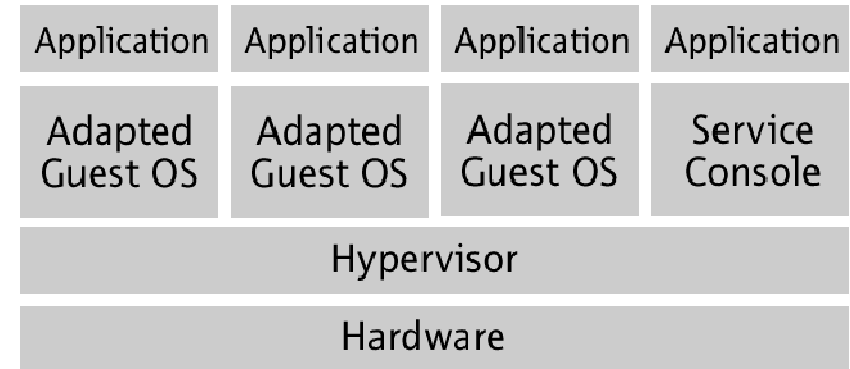

Hypervisor Market Overview

Example of Space Separation

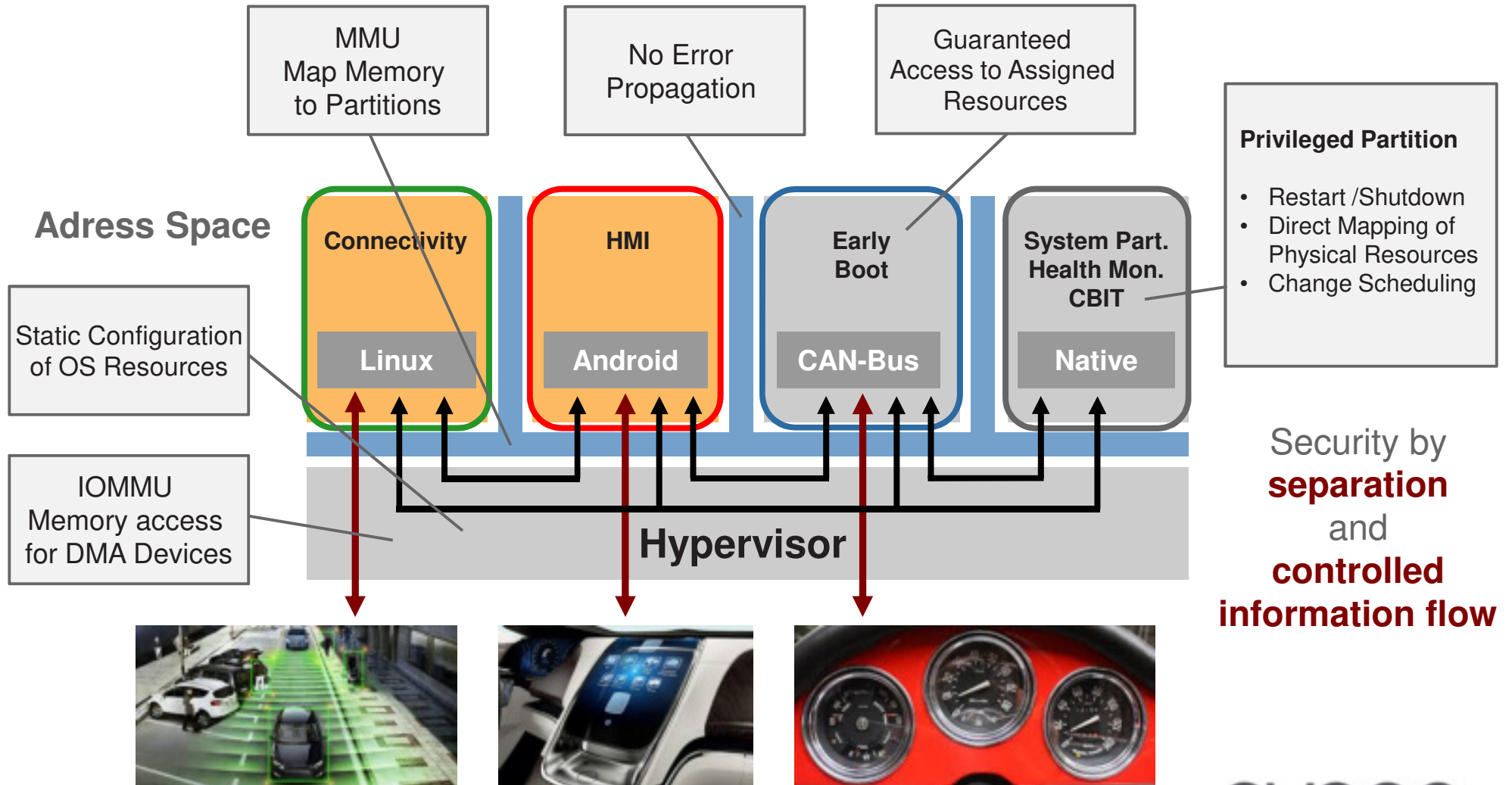

Hypervisor Market Overview

Time Partitioning

A) Priority based scheduler

- **Static or dynamic configuration of:**
 - Execution order
 - Duration
- **Deterministic Hard Real-time**
- **Shortest response time**
 - Dedicated thread with superior priority
- **Best possible CPU usage**

B) Cyclic scheduler

- E.g. Round Robin

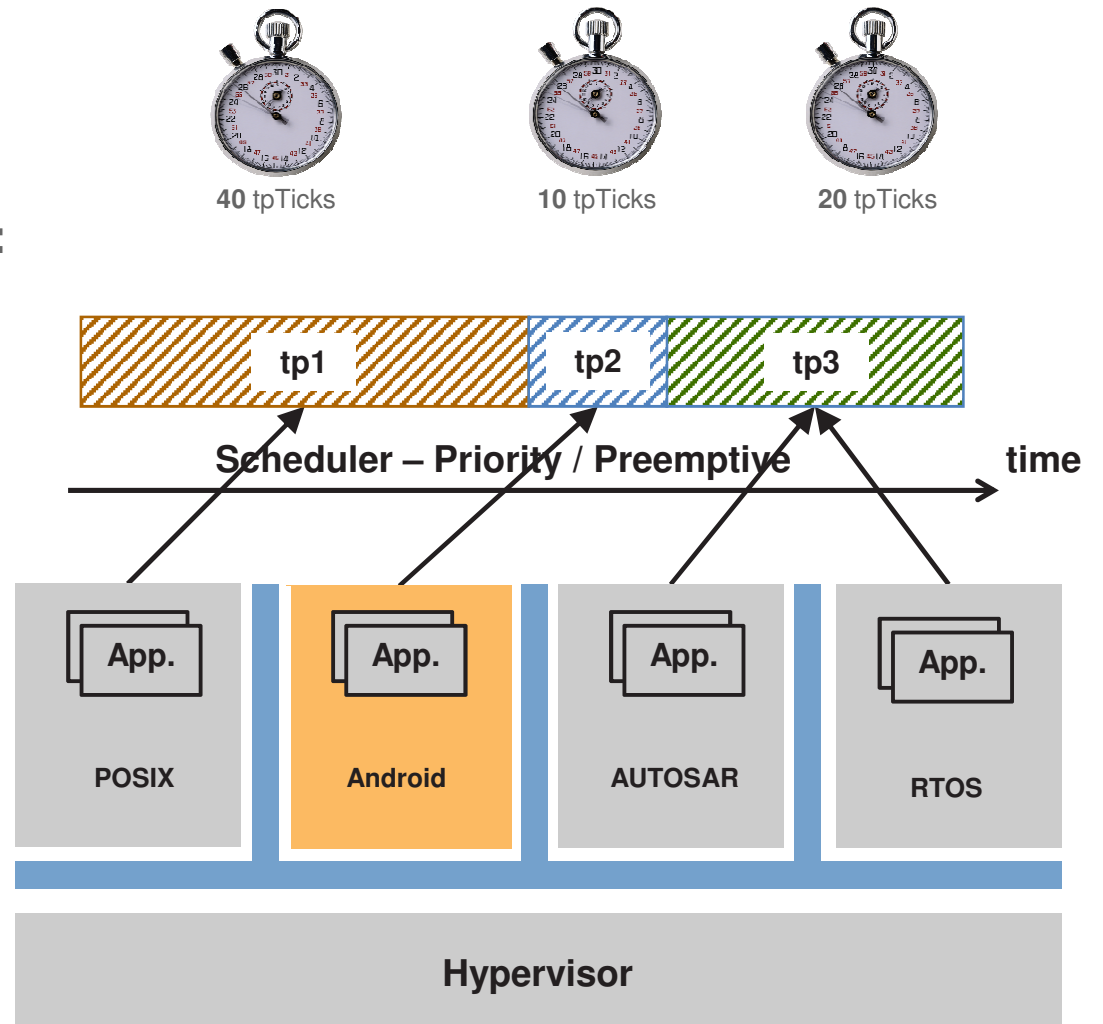

Hypervisor Market Overview

Multiplexed Virtual Serial

- **Every virtual board has access to serial port**
 - On Intel with emulated devices, other arches with stub drivers
- **IDE can show all tabs**
 - IO to each guest individually
- **Easy way of bringing up guests**

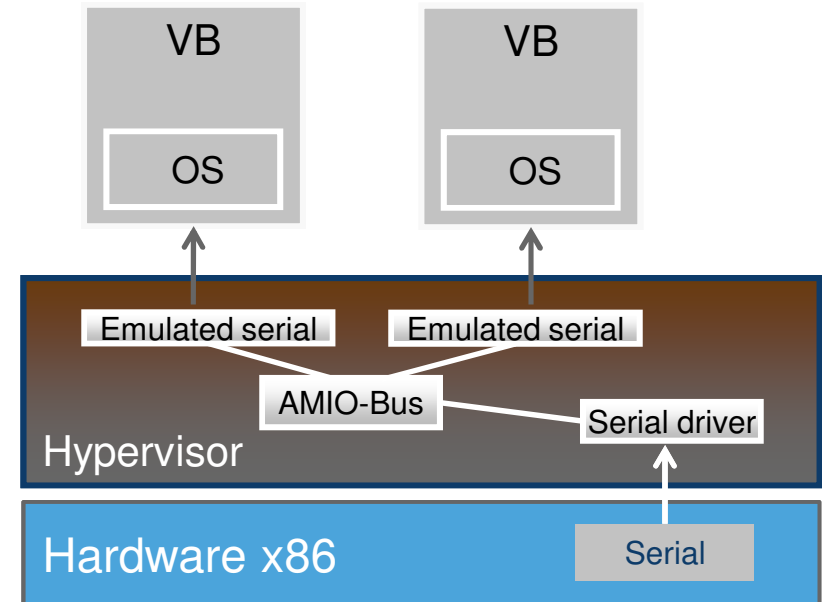

Hypervisor Market Overview

Linux based hypervisor



Abbildung 3.1-1: Aufbau von RT-Linux

Acc. To Prof. Frank Golatowski

Hypervisor Market Overview

Hypervisor versus Linux Containers

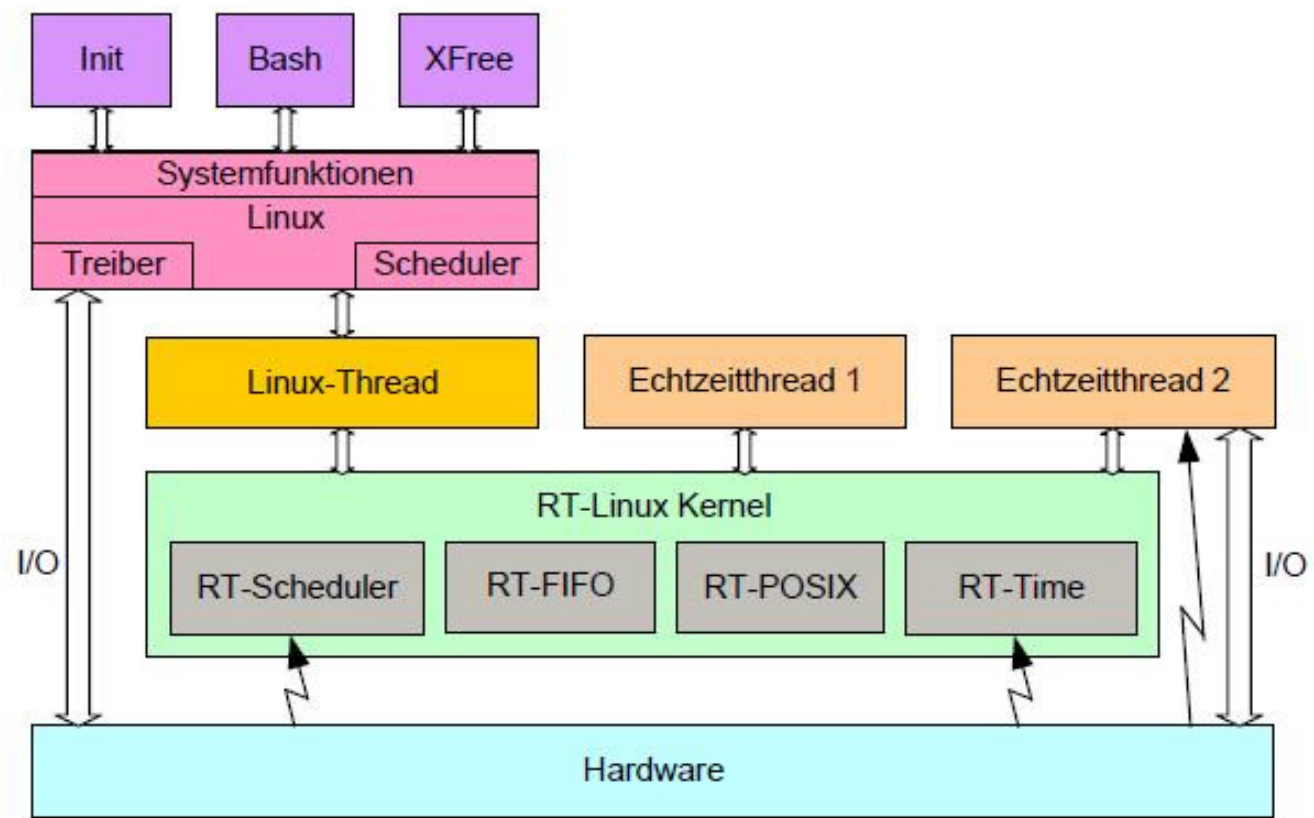
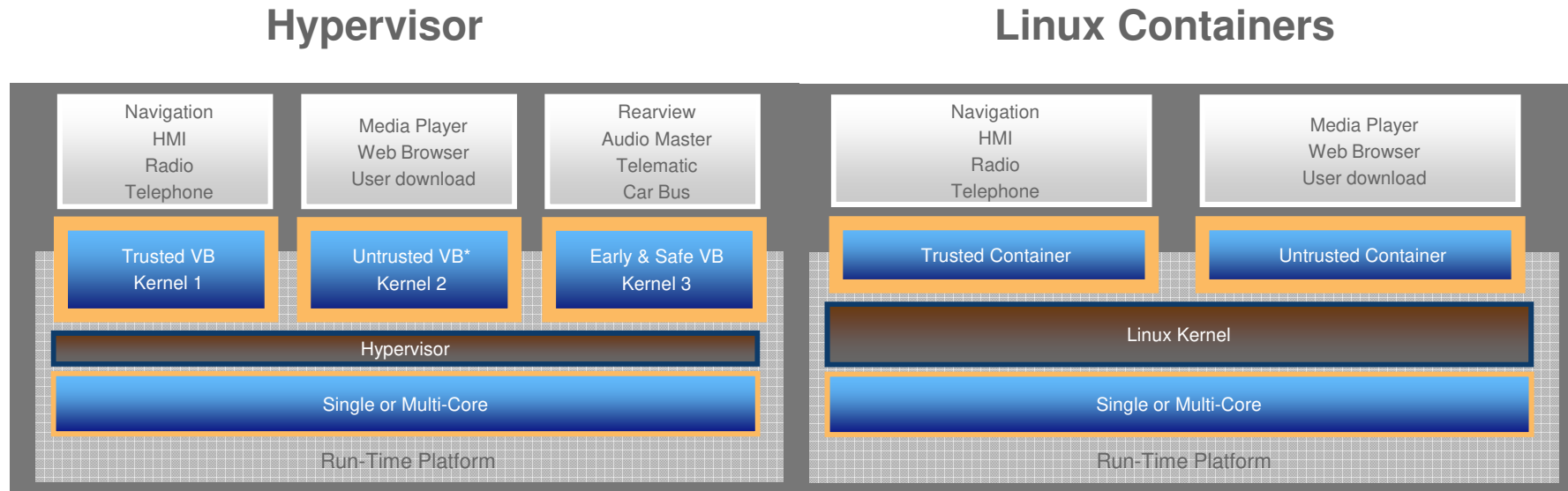

* Another Linux or Android OS

- Hypervisor allows real-time with a virtual machine monitor (**Note:** Linux containers do not protect from user to kernel privilege escalation attacks)
- It allows Linux or other OS to run in one of the partitions as a guest OS
- It virtually allows that any and all real-time tasks have priority over Linux kernel tasks
- Secure boot scenarios are possible with low boot times

System Safety

Software Standards for Safety Related Systems

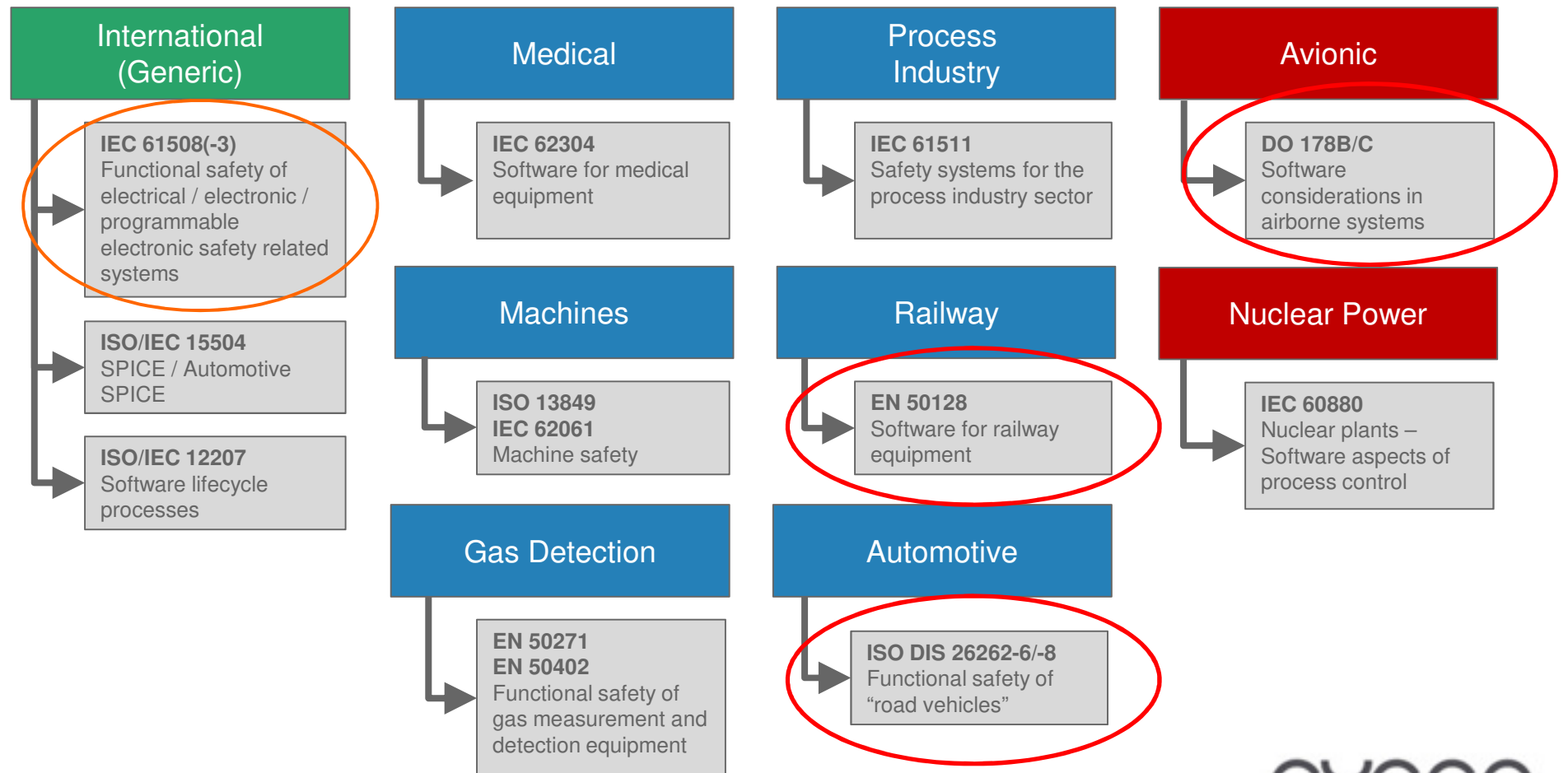

Compliance to the ISO 26262 SW Phase Model

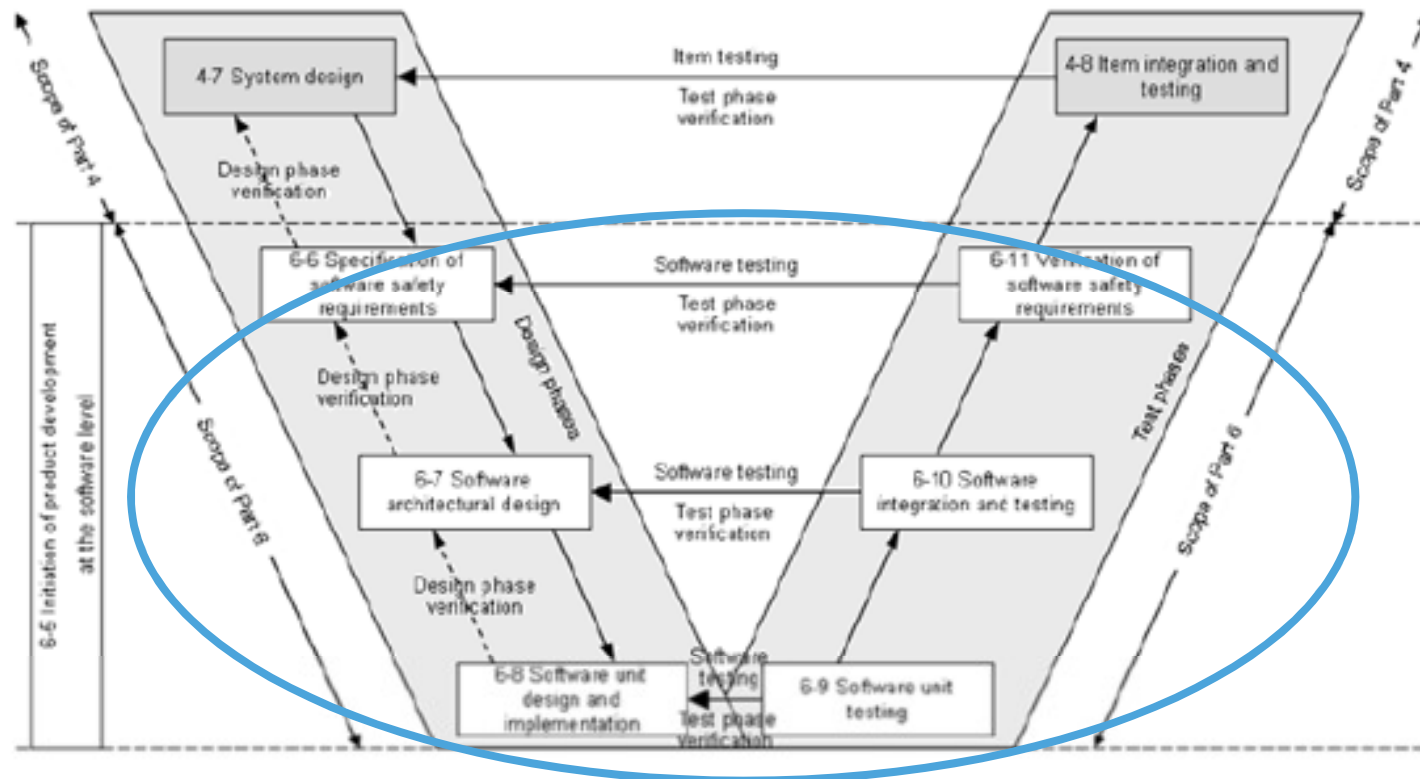

NOTE Within the figure, the specific clauses of each part of ISO 26262 are indicated in the following manner: "m-n", where "m" represents the number of the part and "n" indicates the number of the clause, e.g. "4.7" represents Clause 7 of ISO 26262-4.

Figure 2 — Reference phase model for the software development

Hypervisor Market Overview

Summary & Outlook

- Hypervisors have a major play in safe and secure embedded systems
- Wide set of use cases are possible
- There are many different HV variants
- Automotive market is just starting to use HV
- The market density of hypervisor vendors is increasing
- They are often combined with an RTOS offering (partially included)
- Hypervisors vary on
 - Supported architectures and number of BSPs
 - Time and/or space separation
 - MMU or MPU support
 - Feature details and specification
 - Configuration in the tool chain
 - Supported levels of safety and security software standards

Hypervisor Market Overview

Questions?

Franz Walkembach
VP Marketing & Product Strategy

focal.auto@sysgo.com

Contact

SYSGO AG
Am Pfaffenstein 14
55270 Klein-Winternheim
Germany

SYSGO AG
Phone: +49 6136 9948-0
sales-de@sysgo.com

SYSGO S.A.S.
Phone: +33 1 30 09 12 70
sales-fr@sysgo.com

SYSGO s.r.o.
Phone: +420 222 138 111
sales-cz@sysgo.com



sysgo
EMBEDDING INNOVATIONS

www.sysgo.com

